

Article number: 2030100M842A1X

Description: E+G levelling foot

GN 30-100-M8-42-A1-X

Note: X With female thread, Wxternal hexagon

## Measures

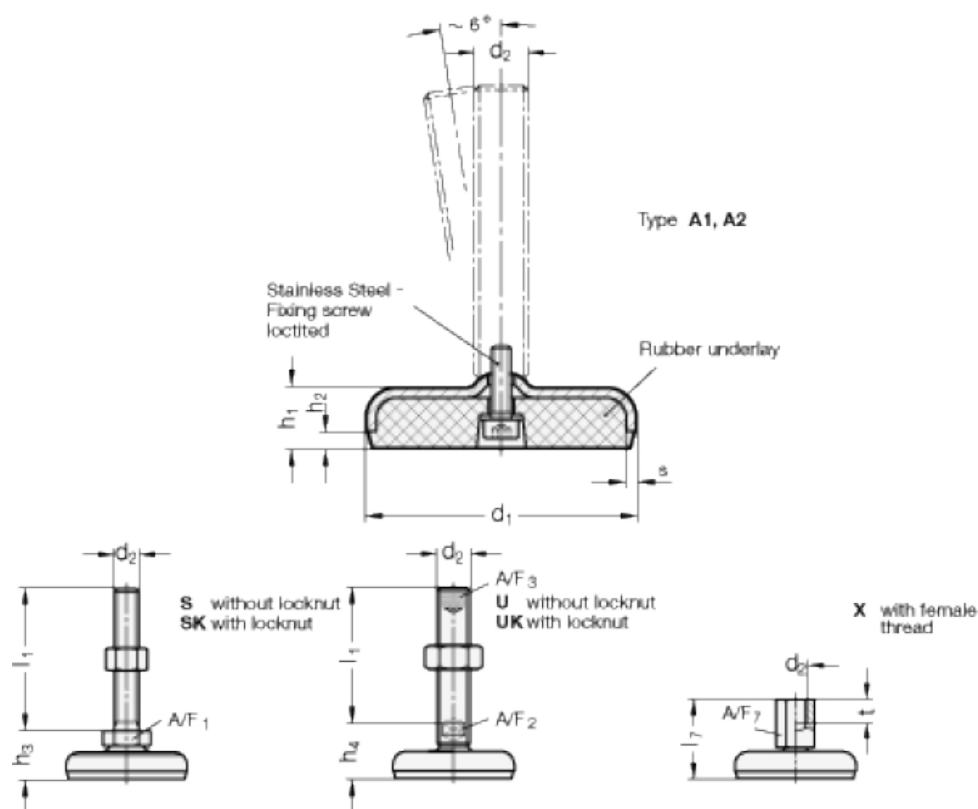

A/F7	= 14
d1	= 100
d2	= M8
h1	= 22
h2	= 6
l7	= 42
s	= 3
t	= 8